

Please, read this manual  
carefully before use!

Owner's Manual



## Handheld vacuum cleaner

KS VC40

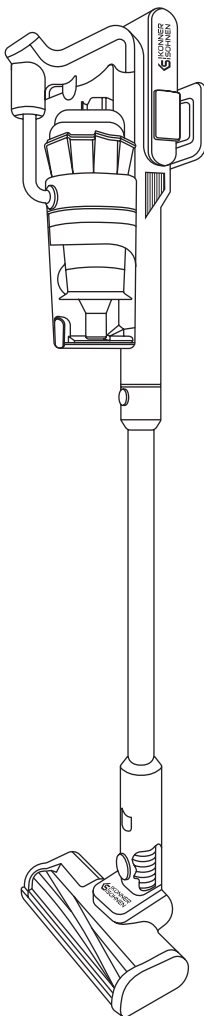



Thank you for your purchase of **Könner & Söhnen®** products. This manual contains a brief description of safety, use and debugging. More information can be found on the official manufacturer's website in the support section: [konner-sohnen.com/manuals](http://konner-sohnen.com/manuals)

You can also go to the support section and download the manual by scanning the QR code, or on the website of the official importer of Könner & Söhnen® products: [www.konner-sohnen.com/en-us](http://www.konner-sohnen.com/en-us)



*Please, read this manual carefully before use!*

The manufacturer of **Könner & Söhnen®** products reserves the right to make changes that may not be reflected in this manual, namely:

- The manufacturer reserves the right to make changes in the product design, configuration and construction.
- The images and drawings in this manual are for reference only and may differ from the actual components and inscriptions on the products.

Contact information that you are free to use in case of any problems can be found at the end of this manual. All information in this manual is correct to the best of our knowledge and belief at the date of its publication. The current list of service centers can be found on the official importer's website at [www.konner-sohnen.com/en-us](http://www.konner-sohnen.com/en-us)



**ATTENTION - DANGER!**



**Failure to follow the recommendations marked with this sign may lead to serious injury of the operator or third parties.**



**IMPORTANT!**



**Useful information while operating the machine.**

## SAFETY WARNINGS

1

1. Carefully read and understand all safety instructions and precautions in this user manual before using your vacuum cleaner.
2. This vacuum cleaner is designed and intended for household use only. It is not intended for industrial or commercial use.
3. Before each use, carefully inspect the vacuum cleaner for any visible damage to ensure that it is in good working condition. Do not use the vacuum cleaner if you notice any malfunctions.
4. Before plugging in the vacuum cleaner, confirm that the voltage rating specified on its nameplate agrees with that of your local mains supply. Connecting to a mains supply with incorrect voltage can damage the vacuum cleaner.
5. Avoid using your vacuum cleaner to pick up the following objects or substances:
  - water, flammable liquids and other liquid materials;
  - burning cigarette butts, smoldering charcoal or ashes, other burning or hot objects;
  - sharp or dangerous items that could damage the vacuum cleaner or endanger the user;
  - particles of wood, gypsum, putty, cement, lime, or other hard materials that may get compacted in the vacuum cleaner and cause damage.
6. Keep the vacuum cleaner away from stoves, heaters and other heat sources. Exposure to heat can deform and discolor the plastic parts of the vacuum cleaner.
7. Never leave the vacuum cleaner unattended while it is plugged in or running. Keep the unit out of the reach of children.
8. Always disconnect the vacuum cleaner from the power supply and remove the battery before cleaning, attempting any maintenance task, fitting or removing accessories. This prevents unintentional power-on and ensures safety during maintenance.

9. Never use alcohol or other solvents to clean the unit.
10. Always unplug the unit from the power supply when it is not charging.
11. If the vacuum cleaner generates any abnormal noise, odor or smoke, power it off immediately, remove the battery and have the vacuum cleaner inspected or repaired at an authorized service center.
12. Ensure the lithium-ion battery (INR18650-2200) is installed correctly in the unit. Always remove the battery when it is empty or if you will not be using the vacuum cleaner for a long time.
13. Always use only the original charger supplied with your vacuum cleaner.
14. Before disposing of the unit, remove the battery and observe local laws and regulations regarding disposal of lithium-ion batteries. Never dispose of the battery with household waste.
15. Use the attachments and accessories supplied with your vacuum cleaner for their intended purpose. Improper use of the tools and nozzles may endanger the user and damage the unit.
16. Exercise care when using the electric nozzle with rotating brush, i.e. prevent its moving part from being jammed, hit and blocked by objects.

MAIN OVERVIEW

2

1. Cordless Vacuum Cleaner Main Unit
2. Aluminium Tube Release Knob
3. Aluminium Tube
4. Motorized Brush Release Knob
5. Motorized Brush
6. ON/OFF Button
7. Charge Port
8. Dustbin Release Knob
9. Removable Dust Bin
10. Battery Pack
11. Battery Indicator Display

THE PACKAGE INCLUDES:

12. Wall bracket
13. Flat Nozzle
14. Adaptor

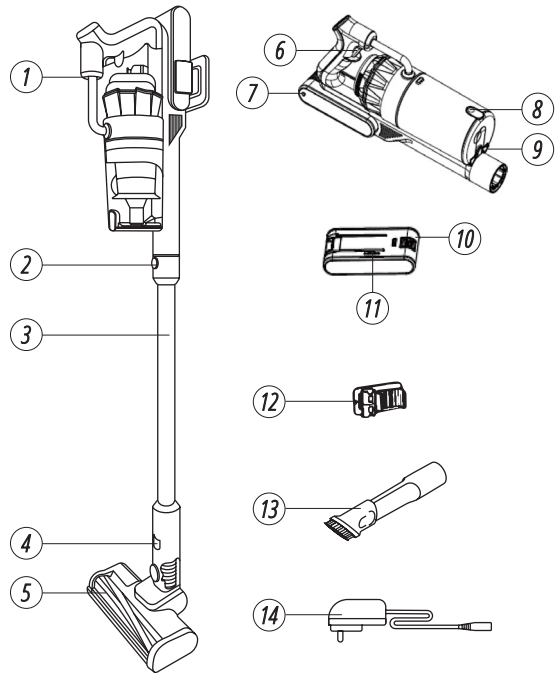

IMPORTANT!



Manufacturer reserves the right to make changes and/or improvements in design, components set and technical attributes without notice and without incurring obligation. The pictures in this manual are schematical and may not match the parameters of original product.

<b>Model</b>	<b>KS VC40</b>
<b>Input voltage</b>	100–240V, 50–60Hz, 0.4A MAX
<b>Output voltage</b>	27V/500mA
<b>Rated power</b>	300 W
<b>3 power modes</b>	High (25000 Pa)/Standard (15000 Pa)/Eco (7000 Pa)
<b>Filtration method</b>	Multi Cyclone+Stainless steel filter
<b>Dustbin volume</b>	15.2 fl. oz
<b>Accumulator</b>	25.9V Li-ion 2200mAh
<b>Charging time</b>	4.5 – 5 h
<b>Operating time in ECO/STANDARD/HIGH modes</b>	7kPa/45 min., 15kPa/25 min., 25kPa/12 min.
<b>Gross dimensions (LxWxH)</b>	27**x5,3**x10"
<b>Gross weight</b>	7.5 lbs
<b>Accessories</b>	1×Wall bracket, 1×Manual, 1×Flat Nozzle, 1×Motorized Brush, 1×Adaptor



NOTE



Before using the Cordless Vacuum cleaner for the first time, dean it with a soft damp doth and dry thoroughly. Do not immerse the Cordless Vacuum cleaner in water or any other liquid.

**1. ASSEMBLING THE CORDLESS VACUUM CLEANER**

Fit the battery pack onto the main body base until it clicks into the position. If you need to remove the battery pack, hold the main body, press the release knob and remove the battery pack.

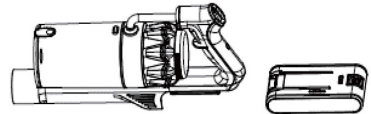

**2. ASSEMBLING THE ALUMINUM TUBE**

Fit the tube onto the main body's air inlet until it clicks into the position. If you need to remove the tube, hold the main body, press the release knob and remove the tube.

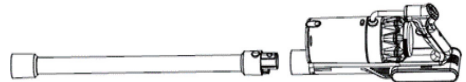

**3. ASSEMBLING THE MOTORIZED BRUSH**

Fit the motorized brush on the tube until it click into the position. If you need to remove the motorized brush, hold the aluminum tube, press the motorized brush release knob and remove the brush from the tube.



**4. ASSEMBLING THE ACCESSORY 2 IN 1 BRUSH**

Fit the 2 in 1 brush or Flat Suction on the main body's air inlet and/or on the tube until it clicks into the position. The 2 in 1 brush and Flat Suction are good for cleaning stairs, in comers.

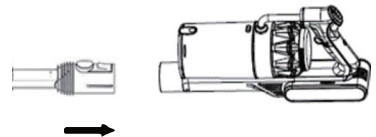

**OPERATING THE CORDLESS VACUUM CLEANER**

Before first time use, ensure the vacuum cleaner has been charged 4 hours. Turn on the Cordless vacuum cleaner by pressing the ON/OFF button.



WARNING!



Do not use the Cordless Vacuum cleaner without the removable filter or dust bin not in position.

**NOTE**

**Battery indicator light represents battery capacity and will illuminate during use. The indicator light will extinguish one at a time as the battery runs out.**

**WARNING!**

**Do not use the Cordless Vacuum cleaner without the removable filter or dust bin not in position.**

### CHARGING THE BATTERY

Turn off the Cordless vacuum cleaner. Connect the adapter to the charging port on the main unit. Plug the adapter into the main power supply. The battery indicator display will flash and illuminate one by one. Once the battery fully charged, the battery indicator display will steady on.

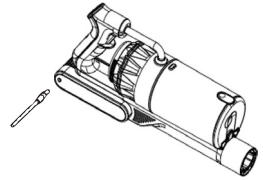
**ATTENTION - DANGER!**

**Do not use any mains power adaptor other than that supplied, as using an alternative will increase the risk of injury and/or damage to main product.**

## CLEANING AND MAINTENANCE

**5**

### FILTER REPLACEMENT AND CLEANING

1. Turn off the Cordless vacuum cleaner.
2. Press the dust bin release knob, remove the dust bin.
3. Come up with the filter, empty the dirt inside.
4. Cleaning the filter in water, wait for it to dry completely.
5. Put the filter back into the dust bin carefully.
6. Put the dust bin back into the main body.

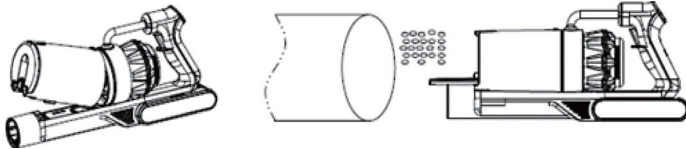

### ROTATING BRUSH CLEANING

1. Turn the brush bottom screw to unlock position (pictured).
2. Open the brush bottom fixed device.
3. Show brush, clean the rotating brush on the twisting thing.
4. Put the rotating brush back.
5. Turn the brush bottom screw to lock position.

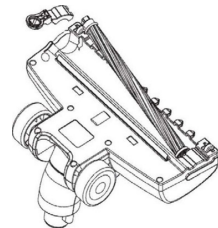

### BATTERY REMOVAL AND DISPOSAL

- Discharge the battery by running the appliance to stop the engine at idle.
- Remove the battery from the appliance.
- Dispose of the battery to a collection of chemical waste from.

Take your cordless vacuum cleaner at the end of the long lifetime is disposed of it in an environmentally friendly way. Discarded batteries are environmentally friendly and disposed of it in accordance with applicable regulations.

## CONTACTS

**The United States:**

KS Energy Solutions, Inc.  
Balcones Drive STE 100 Austin,  
TX 78731, USA

**Authorized Warranty Service**

[support.us@dimaxgroup.com](mailto:support.us@dimaxgroup.com)

[www.konner-sohnen.com/en-us](http://www.konner-sohnen.com/en-us)